

RICOH

AficioTM
CL3000/CL3000DN

Option Setup Guide

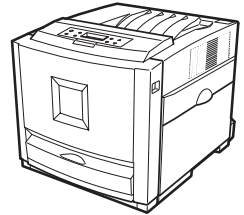

For safety, please read this manual carefully before you use this product and keep it handy for future reference.

ZPIntroduction

To get maximum versatility from this machine all operators should carefully read and follow the instructions in this manual. Please keep this manual in a handy place near the machine.

Please read the Safety Information before using this machine. It contains important information related to USER SAFETY and PREVENTING EQUIPMENT PROBLEMS.

Important

Contents of this manual are subject to change without prior notice. In no event will the company be liable for direct, indirect, special, incidental, or consequential damages as a result of handling or operating the machine.

Caution:

Use of controls or adjustment or performance of procedures other than those specified in this manual might result in hazardous radiation exposure.

Do not attempt any maintenance or troubleshooting other than that mentioned in this manual. This printer contains a laser beam generator and direct exposure to laser beams can cause permanent eye damage.

Notes:

Some illustrations in this manual might be slightly different from the machine.

Certain options might not be available in some countries. For details, please contact your local dealer.

Two kinds of size notation are employed in this manual. With this machine refer to the metric version.

For good copy quality, supplier recommends that you use genuine supplier's toner.

Supplier shall not be responsible for any damage or expense that might result from the use of parts other than genuine supplier's office product.

Trademarks

Microsoft, Windows and Windows NT are registered trademarks of Microsoft Corporation in the United States and/or other countries.

IPS-PRINT Printer Language Emulation Copyright© 1999-2000 Oak Technology, Inc., All rights reserved.

Other product names used herein are for identification purposes only and might be trademarks of their respective companies. We disclaim any and all rights in those marks.

The proper names of the Windows operating systems are as follows:

- The product name of Windows® 95 is Microsoft® Windows® 95.
- The product name of Windows® 98 is Microsoft® Windows® 98.
- The product name of Windows® Me is Microsoft® Windows® Millennium Edition (Windows Me).
- The product names of Windows® 2000 are as follows:
Microsoft® Windows® 2000 Advanced Server
Microsoft® Windows® 2000 Server
Microsoft® Windows® 2000 Professional
- The product names of Windows® XP are as follows:
Microsoft® Windows® XP Professional
Microsoft® Windows® XP Home Edition
- The product names of Windows NT® 4.0 are as follows:
Microsoft® Windows NT® Server 4.0
Microsoft® Windows NT® Workstation 4.0

TABLE OF CONTENTS

How to Read This Manual 1

1. Options

Available Options.....3
PAPER FEED UNIT Type 30008
AD440 (Duplex Unit) 11
Memory Unit Type C (SDRAM Module) 13
Printer Hard Disk Type 3000 16
 Formatting the Printer Hard Disk drive 18
1394 Interface Unit Type 4510..... 19
 Connecting the cable to the 1394 Interface Unit 22
 IEEE 1394 Configuration..... 22
802.11b Interface Unit Type A.....25
 IEEE 802.11b (Wireless LAN) Configuration 28
Bluetooth Interface Unit Type A32
Network Interface Board Type 300035
 Connecting the Network Interface Cable to the Network 37
User Account Enhance Unit Type B.....38
INDEX..... 41

How to Read This Manual

Symbols

In this manual, the following symbols are used:

WARNING:

This symbol indicates a potentially hazardous situation which, if instructions are not followed, could result in death or serious injury.

CAUTION:

This symbol indicates a potentially hazardous situation which, if instructions are not followed, may result in minor or moderate injury or damage to property.

* The statements above are notes for your safety.

Important

If this instruction is not followed, paper might be misfed, or data might be lost. Be sure to read this.

Preparation

This symbol indicates the prior knowledge or preparations required before operating.

Note

This symbol indicates precautions for operation, or actions to take after misoperation.

Limitation

This symbol indicates numerical limits, functions that cannot be used together, or conditions in which a particular function cannot be used.

Reference

This symbol indicates a reference.

[]

Keys that appear on the machine's panel display.

Keys and buttons that appear on the computer's display.

【 】

Keys built into the machine's control panel.

Keys on the computer's keyboard.

1. Options

Available Options

CAUTION:

- Before installing options, the machine should be turned off and unplugged for at least an hour. Components inside the machine become very hot, and can cause a burn if touched.
- Before moving the machine, unplug the power cable from the outlet. If the cable is unplugged abruptly, it could become damaged. Damaged plugs or cables can cause an electrical or fire hazard.
- When lifting the machine, use the grips on both sides. The machine could break or cause an injury if dropped.

By installing options, you can improve the printer performance and have an expanded variety of features to use. For the specifications of each option, see the Administrator Reference.

Option List

	Basic model Printer	Network standard model Printer
PAPER FEED UNIT Type 3000	<input type="radio"/>	<input type="radio"/>
AD440 (Duplex Unit)	<input type="radio"/>	
Memory Unit Type C	<input type="radio"/>	<input type="radio"/>
Printer Hard Disk Type 3000	<input type="radio"/>	<input type="radio"/>
1394 Interface Unit Type 4510	<input type="radio"/> *1	<input type="radio"/> *2
802.11b Interface Unit Type A	<input type="radio"/> *1	<input type="radio"/> *2
Bluetooth Interface Unit Type A	<input type="radio"/> *1	<input type="radio"/> *2
Network Interface Board Type 3000	<input type="radio"/> *1	
User Account Enhance Unit Type B	<input type="radio"/>	<input type="radio"/>

Available option

*1 With Basic model, these cannot be installed at the same time

*2 With Network standard model, these cannot be attached at the same time.

When installing multiple options on the printer, we recommend the following order of installation.

Important

The voltage rating of the connector for options is 24V DC or less.

◆ Option Installation Flow Chart

1 Attach the Paper Feed Unit. (PAPER FEED UNIT Type 3000) ▼	Attach the Paper Feed Unit to the bottom of the printer. You can attach up to two Paper Feed Units.
2 Install the Duplex Unit. (AD440) ▼	Install the unit to the back of the front cover.
3 Install the SDRAM Module. (Memory Unit Type C) ▼	Install the module to the SDRAM module slot on the controller board. 64MB, 128MB, and 256MB Memory Units are available.
4 Install the Printer Hard Disk. (Printer Hard Disk Type 3000) ▼	Install the Printer Hard Disk to the controller board.
5 Install the 1394 Interface Unit. (1394 Interface Unit Type 4510) ▼	Install the 1394 Interface Unit to the slot on the controller board. If you choose to install the 1394 Interface Unit, remove the USB2.0 Interface Board and you cannot install the 802.11b Interface Unit or Bluetooth Interface Unit.
6 Install the 802.11b Interface Unit (802.11b Interface Unit Type A) ▼	Install the 802.11b Interface Unit to the slot on the controller board. If you choose to install the 802.11b Interface Unit, remove the USB2.0 Interface Board and you cannot install the 1394 Interface Unit or Bluetooth Interface Unit.
7 Install the Bluetooth Interface Unit (Bluetooth Interface Unit Type A) ▼	Install the Bluetooth Interface Unit to the slot on the controller board. If you choose to install the Bluetooth, remove the USB2.0 Interface Board and you cannot install the 802.11b Interface Unit or 1394 Interface Unit.
8 Install the Network Interface Board (Network Interface Board Type 3000) ▼	Install the Network Interface Board to the slot on the controller board, only for basic model printer. If you choose to install the Network Interface Board, you cannot install the 1394 Interface Unit, 802.11b Interface Unit or Bluetooth Interface Unit.

<p>9</p> <p>Install the User Account Enhance Unit. (User Account Enhance Unit Type B)</p> <p style="text-align: center;">▼</p>	<p>Install the module to the User Account Enhance Unit slot on the controller board.</p>
---	--

1

Install options in the positions as shown in the illustration.

◆ **Exterior**

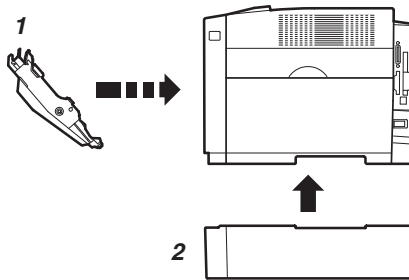

ZHBH050E

1. AD440 (Duplex Unit)

Install to the back of the front cover.
Makes duplex prints.
See p.11 “AD440 (Duplex Unit)”.

2. PAPER FEED UNIT Type 3000

Loads up to 530 sheets of paper. Up to two units can be attached to the printer. "Tray 2" appears on the panel display for the first unit and "Tray 3" appears on the panel display for the second unit.
See p.8 “PAPER FEED UNIT Type 3000”

◆ Basic model Printer : Interior

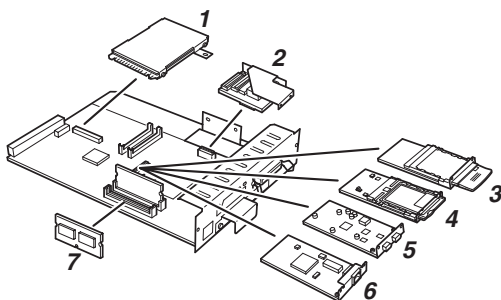

ZHBHA061E

1. Printer Hard Disk Type 3000

Install Printer Hard Disk to the controller board.

See p.16 "Printer Hard Disk Type 3000".

2. User Account Enhance Unit Type B

See p.38 "User Account Enhance Unit Type B".

3. 802.11b Interface Unit Type A

Note

- 802.11b Interface Unit, USB2.0 Interface Board, Bluetooth Interface Unit and 1394 Interface Unit cannot be installed in the printer at the same time.

See p.25 "802.11b Interface Unit Type A".

4. Bluetooth Interface Unit

Note

- Bluetooth Interface Unit, USB2.0 Interface Board, 802.11b Interface Unit and 1394 Interface Unit cannot be installed in the printer at the same time.

5. 1394 Interface Unit Type 4510

Note

- 1394 Interface Unit, USB2.0 Interface Board, Bluetooth Interface Unit and 802.11b Interface Unit cannot be installed in the printer at the same time.

See p.19 "1394 Interface Unit Type 4510".

6. Network Interface Board Type 3000

Note

- Network Interface Board, USB2.0 Interface Board, 802.11b Interface Unit, Bluetooth Interface Unit and 1394 Interface Unit cannot be installed in the printer at the same time.

7. Memory Unit Type C (SDRAM Module)

Install 64MB, 128MB, or 256MB RAM into the slot on the controller board.

See p.13 "Memory Unit Type C (SDRAM Module)".

Important

- Remove USB2.0 Interface Board when you install 1394 Interface Unit, 802.11b Interface Unit, Bluetooth Interface Unit or Network Interface Board.

◆ Network standard model Printer : Interior

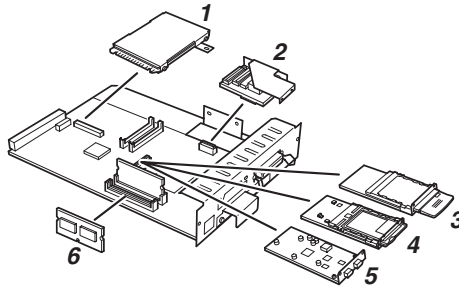

ZHBHA06GE

1. Printer Hard Disk Type 3000

Install Printer Hard Disk to the controller board.

See p.16 "Printer Hard Disk Type 3000".

2. User Account Enhance Unit Type B

See p.38 "User Account Enhance Unit Type B".

3. 802.11b Interface Unit Type A

🔧 Note

- ❑ 802.11b Interface Unit, USB2.0 Interface Board, Bluetooth Interface Unit and 1394 Interface Unit cannot be installed in the printer at the same time.

See p.25 "802.11b Interface Unit Type A".

4. Bluetooth Interface Unit

🔧 Note

- ❑ Bluetooth Interface Unit, USB2.0 Interface Board, 802.11b Interface Unit and 1394 Interface Unit cannot be installed in the printer at the same time.

5. 1394 Interface Unit Type 4510

🔧 Note

- ❑ 1394 Interface Unit, USB2.0 Interface Board, Bluetooth Interface Unit and 802.11b Interface Unit cannot be installed in the printer at the same time.

See p.19 "1394 Interface Unit Type 4510".

6. Memory Unit Type C (SDRAM Module)

Install 64MB, 128MB, or 256MB RAM into the slot on the controller board.

See p.13 "Memory Unit Type C (SDRAM Module)".

⚠ Important

- ❑ Remove USB2.0 Interface Board when you install 1394 Interface Unit, 802.11b Interface Unit, Bluetooth Interface Unit.

PAPER FEED UNIT Type 3000

1

Preparation

When installing multiple options, install the Paper Feed Unit first.

Up to two Paper Feed Units can be attached to the printer. When installing two Paper Feed Units, connect the two units first by following the procedure below before connecting the units to the printer. Then, place the printer on the connected two Paper Feed Units.

CAUTION:

- When moving the machine, each person should hold the handles that are located on opposite sides, and then lift the machine slowly. Lifting it carelessly or dropping it may cause an injury.
- When moving the Paper Feed Unit, hold the handles that are located on the top of the unit, and then lift it slowly. Lifting it carelessly or dropping it may cause an injury.

Note

- The printer weighs approximately 29.4 kg (64.8 lb.bond).
- The Paper Feed Unit weighs approximately 7.42 kg (16.4 lb.bond).
- "Tray 2" appears on the panel display when only one unit is installed. "Tray 3" appears on the panel display for the second unit when two units are installed.

1 Check the contents of the package for the following:

- ◆ Paper Feed Unit (including a paper tray)

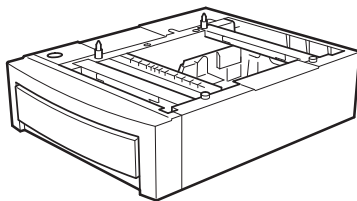

ZHBP310E

2 Turn off the power, and then unplug the power cable.

3 Hold the Paper Feed Unit as shown in the illustration, and then place it on a flat surface near the place where the machine is to be installed.

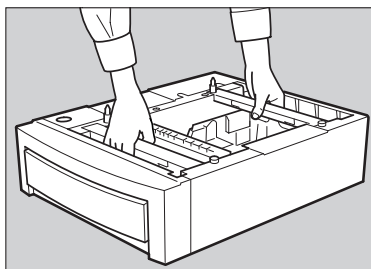

Note

- Be sure to work in a place with enough space, so that you can get behind the printer.

- 4** Pull the paper tray out of the Paper Feed Unit until it stops. After that, lift it slightly, and then pull it out completely. Place it on a flat surface.

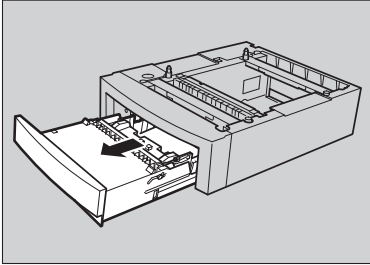

ZHBYA930E

- 5** Remove the adhesive tape and packing material.

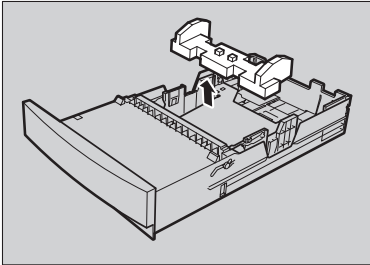

ZHBYA930E

- 6** Slide the paper tray completely into the Paper Feed Unit.

- 7** Lift the printer using the inset grips on both sides of the printer.

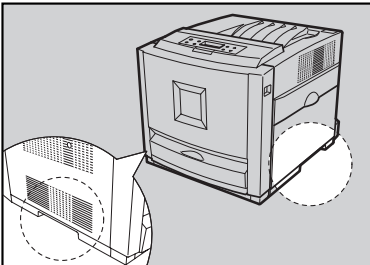

ZHBYA930E

- 8** Align the printer to the two upright pins on the Paper Feed Unit and then lower it slowly.

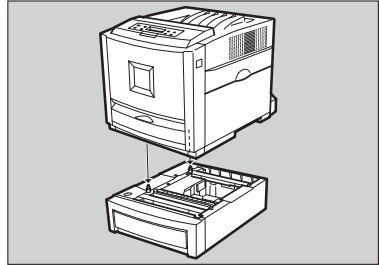

ZHBP340E

Note

- Be sure not to place the printer on the Paper Feed Unit cable.

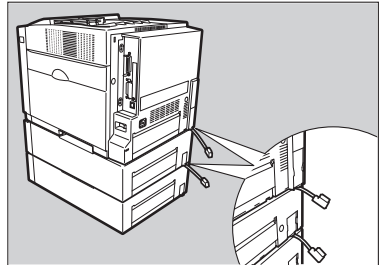

ZHBP390E

- 9** Open the connector cover of the printer.



ZHBP360E

1

- 10** Connect the Paper Feed Unit cable to the socket inside the printer securely.



ZHBP370E

- 11** Close the connector cover of the printer.

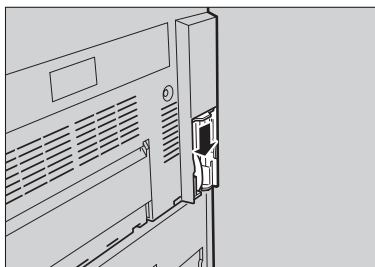

ZHBP380E

To connect two Paper Feed Units, connect the paper feed unit cable to the socket inside the Paper Feed Unit securely, and then close the connector cover.

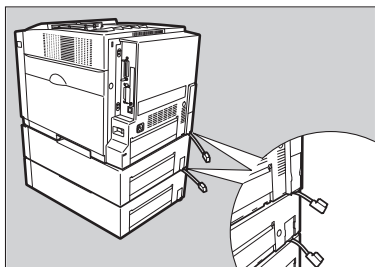

ZHBP390E

Note

- When moving or transporting the printer, make sure to unplug the Paper Feed Unit connector. For more information, see "Moving and Transporting the Printer" in the Maintenance Guide.

Note

- After finishing installation, you can check whether the Paper Feed Unit is installed properly. Print the configuration page from the "List/Test Print" menu. If it is installed properly, you will see "Paper Feed Unit (Tray 2)" or "Paper Feed Unit (Tray 3)" under the "Options" list.
- If the Paper Feed Unit is not installed properly, reinstall it from step **8**. If you cannot install it properly even after attempting reinstallation, contact your sales or service representative.

Reference

For printing the configuration page, see "Making Printer Settings with the Control Panel" in the Administrator Reference.

See "Loading Paper" in the Maintenance Guide.

Important

- Before using the new Paper Feed Unit, you must make settings in the printer driver.

AD440 (Duplex Unit)

⚠ CAUTION:

- The inside of the machine becomes very hot. Do not touch the parts with a "⚠" label (means hot surface). Touching a part with a "⚠" label (means hot surface) could result in a burn.

1 Turn off the power, and then unplug the power cable.

2 Check the contents of the package for the following:

◆ Duplex Unit

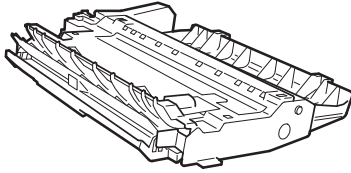

ZHBP240E

3 Open the front cover by pushing the front cover release button.

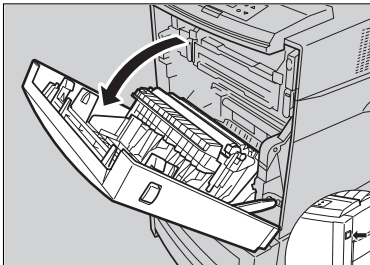

ZHBP260E

4 Hold the Duplex Unit as shown in the illustration, and then insert it into the inside of the front cover.

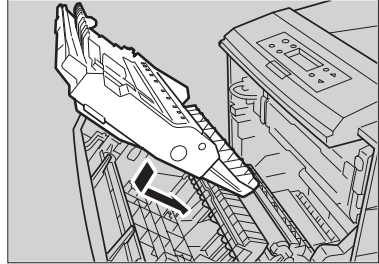

ZHBP270E

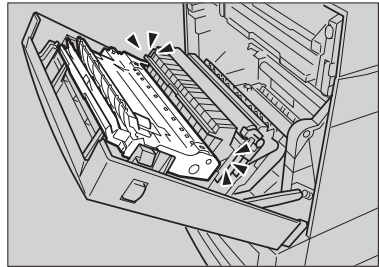

ZHBP280E

Align the arrows, and then insert the Duplex Unit until it clicks.

5 Close the front cover.

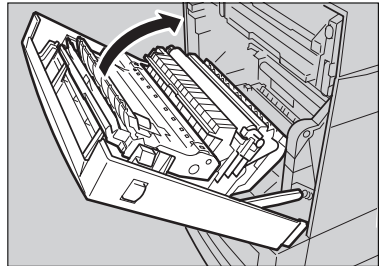

ZHBP282E

 **Note**

- After finishing installation, you can check whether the Duplex Unit is installed properly. Print the configuration page from the "List/Test Print" menu. If it is installed properly, you will see "Duplex Unit" under the "Options" list.
- If the Duplex Unit is not installed properly, reinstall it from step 8. If you cannot install it properly even after attempting reinstallation, contact your sales or service representative.

 **Reference**

See "Making Printer Settings with the Control Panel" in the Administrator Reference for printing the configuration page.

 **Important**

- Before using the Duplex Unit, you must make settings in the printer driver.

Memory Unit Type C (SDRAM Module)

⚠ CAUTION:

- Do not touch the inside of the controller board compartment. It may cause a machine malfunction or a burn.

⚡ Important

- Before touching the Memory Unit, touch something metal to discharge any static electricity. Static electricity can damage the Memory Unit.
- Do not subject the Memory Unit to physical shocks.

1 Turn off the power, and then unplug the power cable.

2 Remove the two screws that fasten the controller board on the back of the printer.

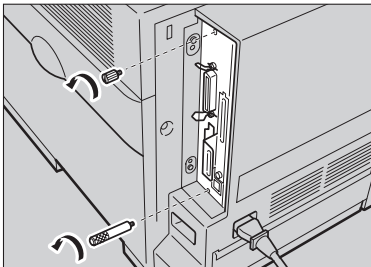

ZHBP090E

The removed screws will be used in step **7** to fasten the controller board.

3 While holding the handle, pull out the controller board slowly.

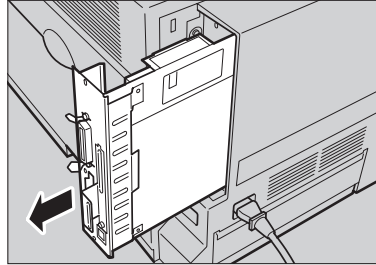

ZHBP020E

There are two slots for the Memory Unit. Use the available slot (the one in the front in the illustration ②) to install an optional Memory Unit.

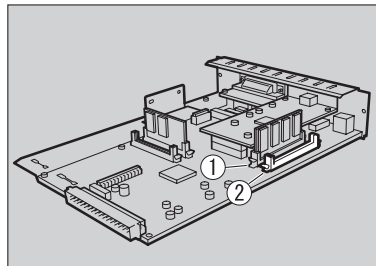

ZHBP100E

⚡ Important

- In order to install the maximum 384 MB memory, remove the standard Memory Unit ①, and then replace with the 128 MB Memory Unit. Then install the 256 MB Memory Unit onto the other slot (the one in the front in the illustration ②).
- When using only one Memory Unit, be sure to use the slot in the back shown in the illustration ①.

Note

- The following is the recommended combination of the Memory Units.

Slot		Total memory
CN2 (back ①)	CN3 (front ②)	
64 MB	None	64 MB
64 MB	64 MB	128 MB
64 MB	128 MB	192 MB
64 MB	256 MB	320 MB
128 MB	256 MB	384 MB

- Adjust the notch of the Memory Unit to the slot, and then insert vertically.

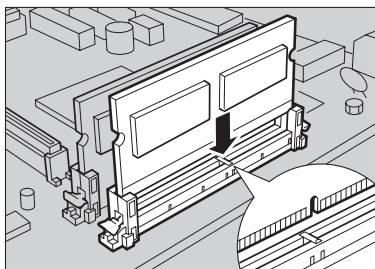

ZHBP110E

- Press the Memory Unit down until it clicks into place.

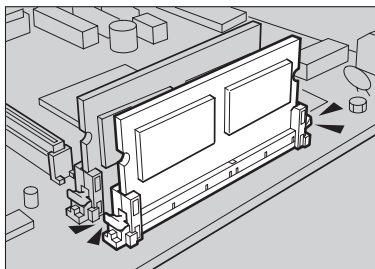

ZHBP120E

- Align the controller board to the top and bottom rails, and then push in slowly until it stops.

Note

- When installing other options on the controller board, do not close the controller board, but go to the steps for installing the option.

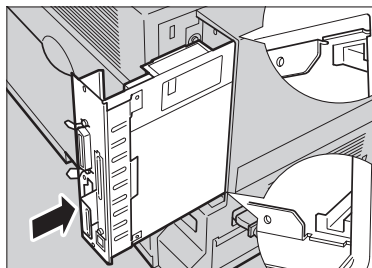

ZHBP070E

Important

- The printer may not work properly if the controller board is not set properly.

- Fasten the controller board to the printer with the two screws that you removed in step 2.

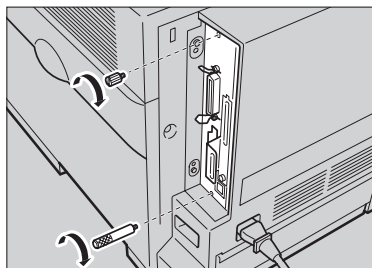

ZHBP010E

 **Note**

- After finishing installation, you can check whether the Memory Unit is installed properly. Print the configuration page from the "List/Test Print" menu. If it is installed properly, you will see the memory capacity for "Total Memory".
- If the Memory Unit is not installed properly, reinstall it from step 1. If you cannot install it properly even after attempting reinstallation, contact your sales or service representative.

 **Reference**

For printing the configuration page, see "Making Printer Settings with the Control Panel" in the Administrator Reference.

 **Important**

- Before using the new Memory Unit, you must make settings in the printer driver.

Printer Hard Disk Type 3000

1

⚠ CAUTION:

- Do not touch the inside of the controller board compartment. It may cause a machine malfunction or a burn.

⚡ Important

- ❑ Before touching the Printer Hard Disk, touch something metal to discharge any static electricity. Static electricity can damage the Printer Hard Disk.
- ❑ Do not subject the Printer Hard Disk to physical shocks.

1 Check the contents of the package for the following:

◆ Printer Hard Disk Type 3000

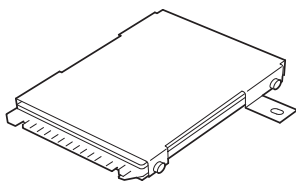

ZHBP0010E

◆ Screw



2 Turn off the power, and then unplug the power cable.

3 Remove the two screws that fasten the controller board on the back of the printer.

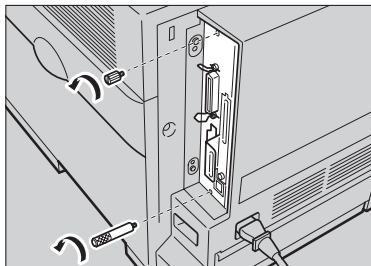

ZHBP0090E

The removed screws will be used in step 3 to fasten the controller board.

4 While holding the handle, pull out the controller board slowly.

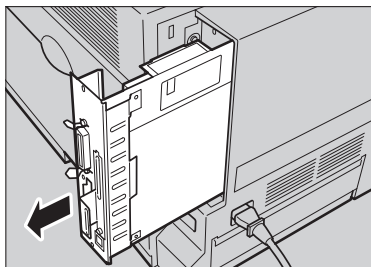

ZHBP020E

The Printer Hard Disk is to be installed to the position shown in the illustration.

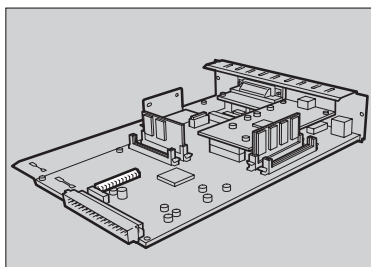

ZHBP160E

- 5** Insert the Printer Hard Disk by aligning it with the controller board slot, sliding it in the direction of the arrow, and then connecting it to the connector on the controller board.

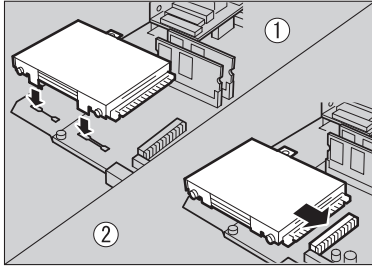

ZHBP170E

- 6** Fasten the Printer Hard Disk using the supplied screw.

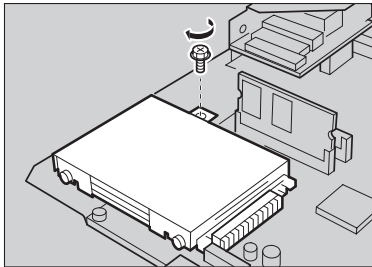

ZHBP180E

- 7** Align the controller board to the top and bottom rails, and then push in slowly until it stops.

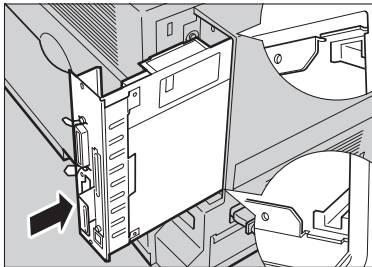

ZHBP070E

Note

- When installing other options on the controller board, do not close the controller board, but go to the steps for installing the option.

Important

- The printer may not work properly if the controller board is not set properly.

- 8** Fasten the controller board to the printer with the two screws that you removed in step 3.

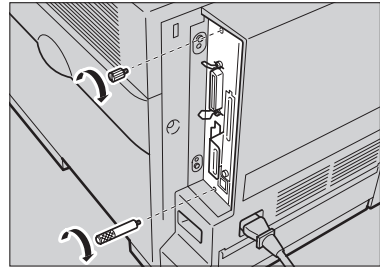

ZHBP010E

When the power is turned on, the Printer Hard Disk will be formatted automatically.

Note

- After finishing installation, you can check whether the Printer Hard Disk is installed properly. Print the configuration page from the "List/Test Print" menu. If it is installed properly, you will see "Printer Hard Disk Drive" for "Controller Option".
- If the Printer Hard Disk is not installed properly, reinstall it from step 2. If you cannot install it properly even after attempting reinstallation, contact your sales or service representative.

Reference

See "Making Printer Settings with the Control Panel" in the Administrator Reference for printing the configuration page.

Important

- Before using the new Printer Hard Disk, you must make the settings in the printer driver.

Formatting the Printer Hard Disk drive

If it becomes necessary to format the Printer Hard Disk after initial setup, execute "HDD Format" in the Maintenance menu.

Important

- Formatting the Printer Hard Disk will delete all data.

1 Press the **[Menu]** key.

"Menu" appears on the panel display.

2 Press the **[▲]** or **[▼]** key to display "Maintenance", and then press the **[Enter #]** key.

```
Menu:
Maintenance
```

3 Press the **[▲]** or **[▼]** key to display "HDD Format", and then press the **[Enter #]** key.

A message to start to format is shown.

Note

- If "HDD Format" is not displayed on the panel display, the Printer Hard Disk is not installed properly. Reinstall it from step **1**. If you cannot install it properly even after the reinstallation, contact your sales or service representative.

Important

- Do not turn off the power while formatting the Printer Hard Disk to avoid a printer malfunction.

4 Press the **[Enter #]** key.

The Printer Hard Disk is formatted, and a message to restart the printer is shown.

5 Turn off the power, and then turn it back on.

Formatting the Printer Hard Disk is completed and it is enabled to use.

1394 Interface Unit Type 4510

⚠ CAUTION:

- Do not touch the inside of the controller board compartment. It may cause a machine malfunction or a burn.

🔧 Important

- ❑ Printing using "1394/Scsi Printer" (Windows 2000) device and "IEEE 1394 and SCSI printers" (Windows XP) with the optional 1394 Interface Unit is possible under Windows 2000 and Windows XP. Printing with IP over 1394 is possible under Windows Me and Windows XP.
- ❑ Under Windows 2000, the 1394 Interface Unit can only be used with Service Pack 1 or later. If the Service Pack is not installed, the connectable SCSI print device in a 1394 bus is only one. The client cannot install the printer driver without using an account with Administrators permission.
- ❑ Before touching the 1394 Interface Unit, touch something metal to discharge any static electricity. Static electricity can damage the 1394 Interface Unit
- ❑ Unplug all the interface cables from the printer before installation. If you take out the controller board with cables plugged in, the 1394 Interface Unit might be damaged.
- ❑ Do not plug or unplug the 1394 interface cable while installing the printer driver
- ❑ Use the 1394 Interface cable that comes with 1394 Interface Unit.

- 1 Check the contents of the package for the following:

- ◆ 1394 Interface Unit Type 4510

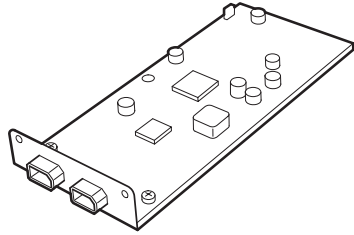

ZHBP400E

- ◆ Interface Cable (6 pins × 6 pins)

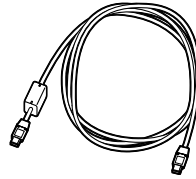

- ◆ Interface Cable (6 pins × 4 pins)



- 2 Turn off the power, and then unplug the power cable and the interface cable.

- 3** Remove the two screws that fasten the controller board on the back of the printer.

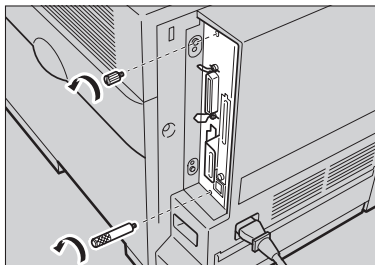

ZHBP080E

The removed screws will be used in step 9 to fasten the controller board.

- 4** While holding the handle, pull out the controller board slowly.

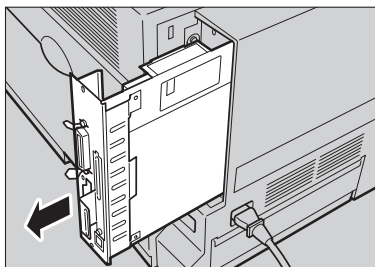

ZHBP020E

- 5** Remove USB2.0 Interface Unit.

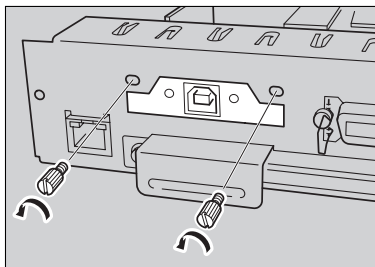

ZHBPB460E

Note

- The removed screws will be used in step 7 to fasten the 1394 Interface Unit.
- Lift the end of USB2.0 Interface Unit (1), and then remove it from the controller board (2).

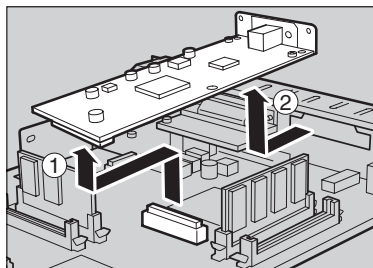

ZHBP450E

- 6** Attach the 1394 Interface Unit to the controller board. Insert the end of the 1394 Interface Unit into the opening (1), and then push down until it clicks (2).

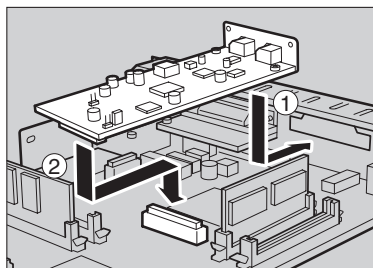

ZHBP050E

Confirm that the 1394 Interface Unit is firmly connected to the controller board.

- 7** Fasten the 1394 Interface Unit on the controller board using the screws that you removed in step **5**.

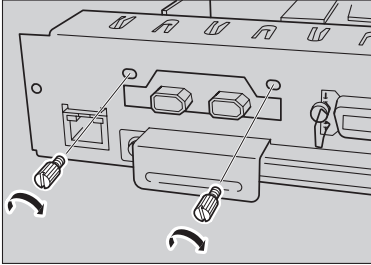

ZHBP060E

- 8** Align the controller board to the top and bottom rails, and then push in slowly until it stops.

Note

- When installing other options on the controller board, do not close the controller board, but go to the steps for installing the option.

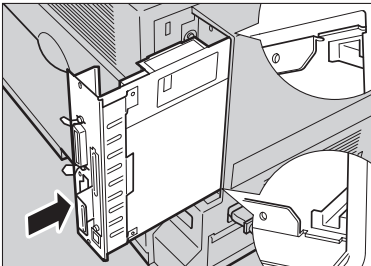

ZHBP070E

Important

- The printer may not work properly if the controller board is not set correctly.

- 9** Fasten the controller board to the printer with the two screws that you removed in step **3**.

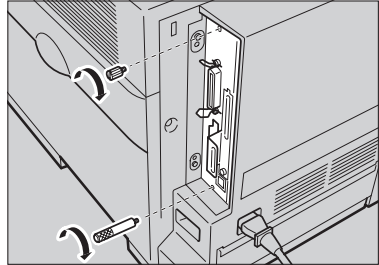

ZHBP010E

Note

- After finishing installation, you can check whether the 1394 Interface Unit is installed properly. Print the configuration page from the "List/Test Print" menu. If it is installed properly, you will see "IEEE1394" for "Controller Option".
- If the 1394 Interface Unit is not installed properly, reinstall it from step **2**. If you cannot install it properly even after attempting reinstallation, contact your sales or service representative.

Reference

See "Making Printer Settings with the Control Panel" in the Administrator Reference for printing the configuration page.

Connecting the cable to the 1394 Interface Unit

1

- 1 Connect the interface cable to the 1394 interface port.

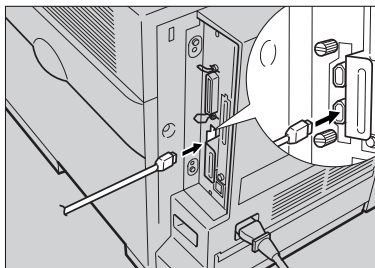

ZHBP090E

Note

- Either connector can be used.
- If you use a interface cable (6 pins x 6 pins) connect the end with the ferrite core to the printer.

- 2 Connect the other end to the host computer.

Important

- You cannot plug devices together to create loops.
- Do not use a cable more than 4.5 meters (14.8 feet) long.

IEEE 1394 Configuration

Use this procedure to configure the printer for use in the IEEE 1394 environment. The following table shows the control panel settings and their default values. These items are included in the "Host Interface" menu.

Setting Name	Value
IP Address1394	000.000.000.000
Subnet Mask1394	000.000.000.000
IP over 1394	Active
SCSI print	Active
Bidi-SCSI print	Active

Depending on the protocol you use, procedures vary. See the following table.

IP over 1394	Steps 1-3 and then go to steps 5 to 7
SCSI print	Steps 1-3 and then go to steps 9 to 11

- 1 Press **[Menu]**.

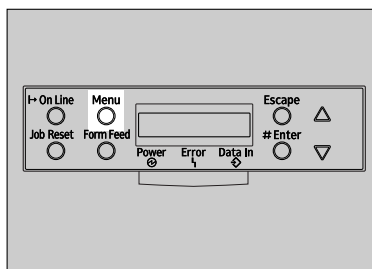

ZHBS010E

"Menu" appears on the panel display.

- 2 Press **[▲]** or **[▼]** to display "Host Interface" menu.

```
Menu:
  Host Interface
```

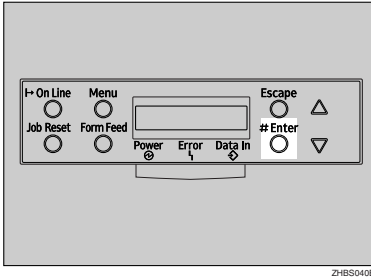
3 Press **[Enter #]**.

The following message appears on the panel display.

```
Host Interface:
I/O Buffer
```

4 Press **[▲]** or **[▼]** to display "IEEE 1394 Setup".

```
Host Interface:
IEEE 1394 Setup
```

5 Press **[Enter #]**.

The following message appears on the panel display.

```
IEEE 1394 Setup:
IP Address1394
```

6 Press **[▲]** or **[▼]** to display "IP over 1394".

```
IEEE 1394 Setup:
IP over 1394
```

- 1** Press **[Enter #]**.
- 2** Press **[▲]** or **[▼]** to select either "Active" or "Not Active".
- 3** Press **[Enter #]**.

The display returns to the previous menu in a few seconds.

7 Assign the IP address to the printer.

Do not overlap the IP address in the same subnet or the same IP address in the network setting.

Note

- To get the IP address for the printer, contact your network administrator.

1 Press **[▲]** or **[▼]** until the following message appears.

```
IEEE 1394 Setup:
IP Address1394
```

2 Press **[Enter #]**.

The current IP address appears on the panel display.

```
IP Address1394:
000.000.000.000
```

3 Press **[▲]** or **[▼]** to enter the leftmost entry field of the IP address.

```
IP Address1394:
192.000.000.000
```

4 Press **[Enter #]**.

The pointer (█) moves to the next entry field automatically.

```
IP Address1394:
192.02█.000.000
```

Note

- The value moves by 10 if **[▲]** or **[▼]** is kept pressed.
- You can return the pointer (█) to the previous (left) entry field by pressing **[Escape]**.

1

- If you press **[Escape]** when the pointer (■) is on the leftmost position, the selected IP address is reset.

- 5** Repeat steps **3** and **4** to enter the IP address.

```
IP Address1394:
 192.168.000.011
```

Check if the pointer (■) is at the rightmost position, and press **[Enter #]** to register the IP address you selected.

```
IEEE 1394 Setup:
IP Address1394
```

- 8** Set "Subnet Mask1394" in the same way.

- 9** Set "SCSI print" and "Bidi-SCSI print" if necessary.

Note

- The default setting is "Active".

- 10** Press **[▲]** or **[▼]** to display "SCSI print".

```
IEEE 1394 Setup:
SCSI Print
```

- 11** Press **[Enter #]**.

The following message appears on the panel display.

```
SCSI Print:
*Active
```

- 12** Press **[▲]** or **[▼]** to select either "Active" or "Not Active", and then press **[Enter #]**.

Set " Bidi-SCSI print " in the same way.

- 13** Press **[On Line]**.

"Ready" appears on the panel display.

```
Ready
```

- 14** Print a configuration page to confirm the settings made. See "Printing a Configuration Page" in the Administrator Reference.

802.11b Interface Unit Type A

⚠ CAUTION:

- Do not touch the inside of the controller board compartment. It may cause a machine malfunction or a burn.

⚡ Important

- Before touching the 802.11b Interface Unit, touch something metal to discharge any static electricity. Static electricity can damage the 802.11b Interface Unit
- Do not subject the 802.11b Interface Unit to physical shocks.

1 Check the contents of the package for the following:

◆ 802.11b Interface Unit Type A

- Interface Unit

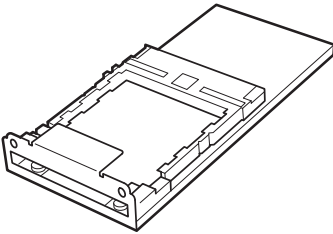

ZHP410E

- Card

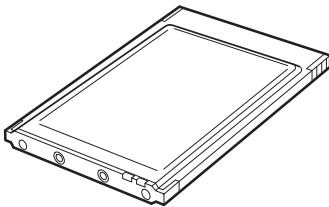

ZHP420E

- Antenna



ZHP430E

2 Turn off the power, and then unplug the power cable.

3 Remove the two screws that fasten the controller board on the back of the printer.

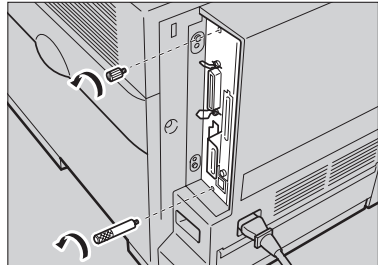

ZHP080E

The removed screws will be used in step 4 to fasten the controller board.

- 4** While holding the handle, pull out the controller board slowly.

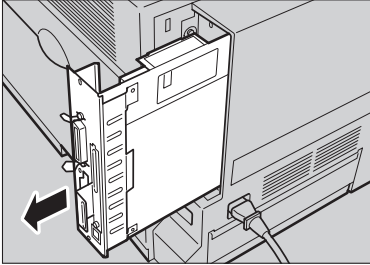

ZHBP020E

- 5** Remove USB2.0 Interface Unit.

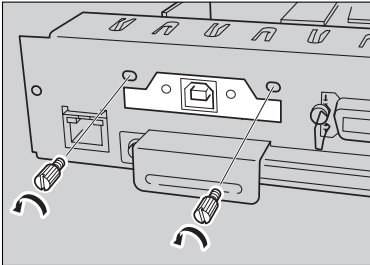

ZHBP040E

 **Note**

- The removed screws will be used in step **7**.
- Lift the end of USB2.0 Interface Unit (①), and then remove it from the controller board (②).

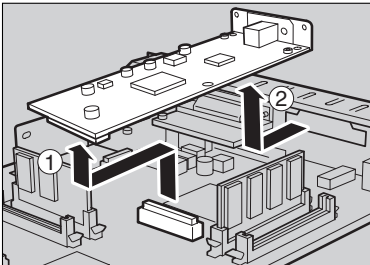

ZHBP050E

- 6** Attach the 802.11b Interface Unit. Insert the end of the 802.11b Interface Unit to the opening (①), and then push down until it clicks (②).

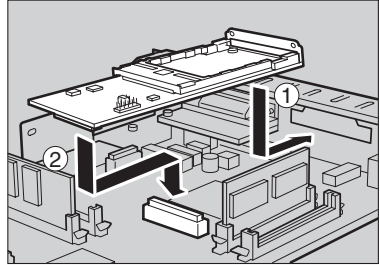

ZHBP190E

Confirm that the 802.11b Interface Unit is firmly connected to the controller board.

- 7** Fasten the 802.11b Interface Unit on the controller board using the screws that you removed in step **5**.

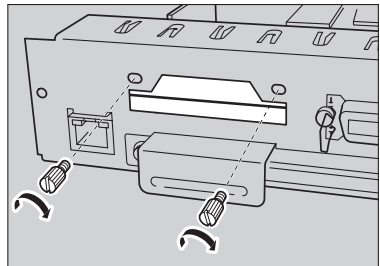

ZHBP200E

- 8** Attach the antenna to the card with the label facing down and the uneven side of the antenna facing up.

- 9** Insert the card slowly into the 802.11b Interface Unit with the label facing down and the uneven black antenna surface facing up until it stops.

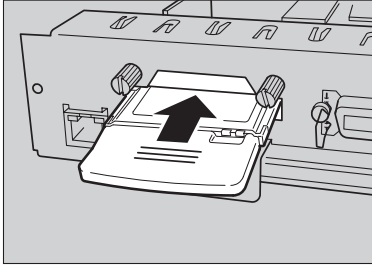

ZHBP210E

- 10** Align the controller board to the top and bottom rails, and then push in slowly until it stops.

Note

- When installing other options on the controller board, do not close the controller board, but go to the steps for installing the option.

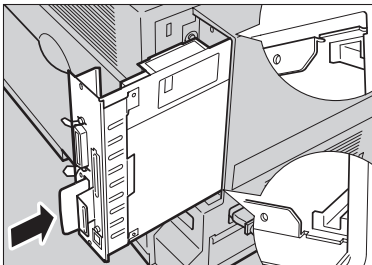

ZHBP220E

Important

- The printer may not work properly if the controller board is not set properly.

- 11** Fasten the controller board to the printer with the two screws that you removed in step **8**.

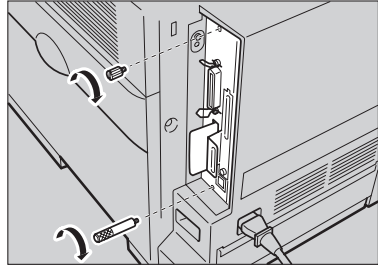

ZHBPB230E

Note

- After finishing installation, you can check whether the 802.11b Interface Unit is installed properly. Print the configuration page from the "List/Test Print" menu. If it is installed properly, you will see "IEEE 802.11b" for "Controller Option".
- If the 802.11b Interface Unit is not installed properly, reinstall it from step **2**. If you cannot install it properly even after attempting reinstallation, contact your sales or service representative.

Reference

See "Making Printer Settings with the Control Panel" in the Administrator Reference for printing the configuration page.

1

IEEE 802.11b (Wireless LAN) Configuration

Configure the printer for using the IEEE 802.11b (Wireless LAN). The following table shows the control panel settings and their default values. These items are included in the "Host Interface" menu.

Setting Name	Default Value
Comm. Mode	802.11 Ad hoc
Channel	<ul style="list-style-type: none"> Inch version (1-11) 11 Metric version (1-13) 11
Trans. Speed	Auto
WEP Setting	Not Active

In order to use the IEEE 802.11b (Wireless LAN), select "IEEE 802.11b" for "LAN Type" in "Network Setup" of the Host Interface menu, and then set "IP Address", "Subnet Mask", "Gateway Address", "DHCP", "Frame Type (NW)" and "Active Protocol" in the "Network Setup". For more information about setting the items in the "Network Setup", see the Quick Installation Guide.

1 Press [Menu].

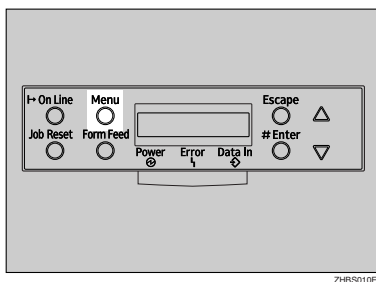

"Menu" appears on the panel display.

2 Press [▲] or [▼] to display "Host Interface" menu.

```
Menu:
Host Interface
```

3 Press [Enter #].

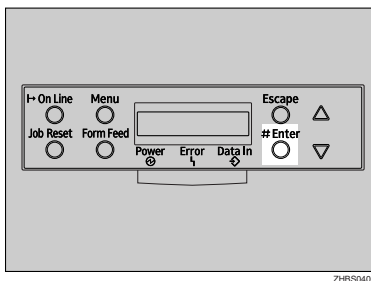

The following message appears on the panel display.

```
Host Interface:
I/O Buffer
```

4 Press [▲] or [▼] to display "IEEE 802.11b".

```
Host Interface:
IEEE 802.11b
```

5 Press [Enter #].

Be sure that "Comm. Mode" appears on the panel display.

```
IEEE 802.11b:
Comm. Mode
```

6 Press [Enter #].

The following message appears on the panel display.

```
Comm. Mode:
*802.11 Ad hoc
```

- 7** Press **[▲]** or **[▼]** to select the transmission mode.

 **Note**

- The factory default is "802.11 Ad hoc".
- To use an IEEE 802.11b card for which the SSID (Network Name) setting is not necessary, select "Ad hoc".

- 8** Press **[Enter #]**.

The display returns to the previous menu in a few seconds.

- 9** If "802.11 Ad hoc" or "Ad hoc" is selected for "Comm. Mode", set the channel to use for transmission.

 **Note**

- Confirm the network administrator for the channel to use.

- 1** Press **[▲]** or **[▼]** to display "Channel".

```
IEEE 802.11b:
Channel
```

- 2** Press **[Enter #]**.

The channel currently used appears on the panel display.

```
Channel:
(1-11)  11
```

- 3** Press **[▲]** or **[▼]** to enter the channel.

- 4** Press **[Enter #]**.

- 10** Set "Trans. Speed" in the same way.

 **Note**

- The factory default is "Auto". If you need to change the transmitting speed depending on environment you are using, select the appropriate transmitting speed.

- 11** Press the **[▲]** or **[▼]** key to display "SSID", and then press the **[Enter #]** key.

```
IEEE 802.11b:
SSID
```

The following message appears on the panel display.

```
SSID:
Enter ID
```

 **Note**

- The factory default is "ASSID".
- If an SSID has been set, you can check the set SSID. Press the **[▲]** or **[▼]** key to display "View", and then press the **[Enter #]** key.

- 1** Press the **[Enter #]** key.

The following message appears on the panel display.

```
SSID:      [ 0 ]
█
```

 **Note**

- The value in brackets at the upper right is the number of characters entered.

1

- ② Press the **[▲]** or **[▼]** key to select characters, and then press the **[Enter #]** key.

```
SSID:      [ 1 ]
A
```

The pointer (█) moves to the next character position.

```
SSID:      [ 1 ]
A█
```

- ③ Continue entering the key.

 **Note**

- The characters that can be used are ASCII 0x20-0x7e (32 bytes).
- If you press the **[Escape]** key, the pointer (█) moves to the previous character position.

- ④ After entering the key, press the **[Enter #]** key twice.

```
SSID:      [32]
AAAAAAAAAAAAAAAAAAAA
```

The screen returns to step ①.

- ⑫ Press the **[▲]** or **[▼]** key to display "WEP Setting".

```
IEEE 802.11b:
WEP Setting
```

- ① Press the **[Enter #]** key.

```
WEP Setting:
*Not Active
```

- ② Press the **[▲]** or **[▼]** key to display "Active", and then press the **[Enter #]** key.

```
WEP Setting:
Active
```

The following message appears on the panel display.

```
Change WEP Key:
Yes
```

 **Note**

- When setting the WEP Setting to "Active", you will need to enter the WEP key. If you have not entered the key, be sure to enter it.
- If you have entered the WEP key and change the setting, press the **[▲]** or **[▼]** key to display "No", and then press the **[Enter #]** key.

- ③ Press the **[Enter #]** key.

```
WEP Key:   [ 0 ]
█
```

 **Note**

- The value in brackets at the upper right is the number of characters entered.

- ④ Press the **[▲]** or **[▼]** key to select characters, and then press the **[Enter #]** key.

```
WEP Key:   [ 1 ]
0
```

The pointer (█) moves to the next character position.

```
WEP Key:   [ 1 ]
0█
```

5 Continue entering the key.**Note**

- You can enter either 10 or 26 characters. If the key you enter is not 10 or 26 characters long, the following message appears.

```
Error: Enter 10
or 26 characters
```

- If you press the **[Escape]** key, the pointer (▄) moves to the previous character position.

6 After entering the key, press the [Enter #] key.

```
WEP Key:   [26]
0000000000000000
```

The screen returns to step 12.

13 Press [On Line].

"Ready" appears on the panel display.

```
Ready
```

14 Print a configuration page to confirm the settings made. See "Printing a Configuration Page" in the Administrator Reference.

Bluetooth Interface Unit Type A

1

⚠ CAUTION:

- Do not touch inside the controller board compartment. It may cause a machine malfunction or a burn.

⚡ Important

- ❑ Before manipulating the Bluetooth Interface Unit, touch any metal thing to discharge static electricity. Static electricity thing damage the Bluetooth Interface Unit.
- ❑ Do not subject the Bluetooth Interface Unit to physical shocks.

1 Check the contents of the package for the following:

◆ Bluetooth

- Interface Unit

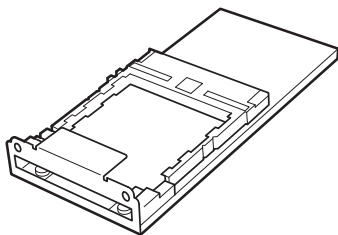

ZHBP410E

- Card

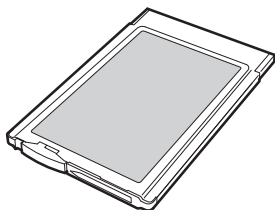

ZHBP510E

- Bluetooth Module

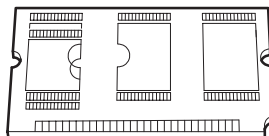

ZHBP520E

- Antenna Cap



ZHBP4921E

2 Turn off the power, and then unplug the power cable.

3 Remove the two screws that fasten the controller board on the back of the printer.

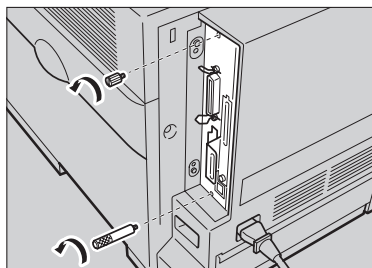

ZHBP080E

The removed screws will be used in step 4 to fasten the controller board.

- 4** While holding the handle, pull out the controller board slowly.

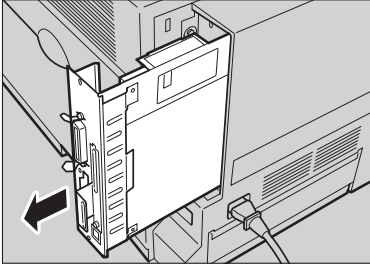

ZHBP020E

- 5** Remove USB2.0 Interface Unit.

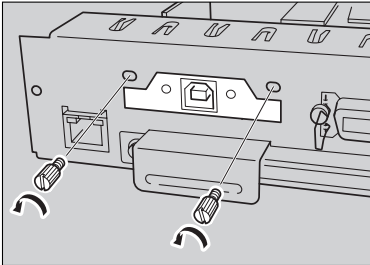

ZHBPB40E

 **Note**

- The removed screws will be used in step **7**
- Lift the end of USB2.0 Interface Unit (①), and then remove it from the controller board (②).

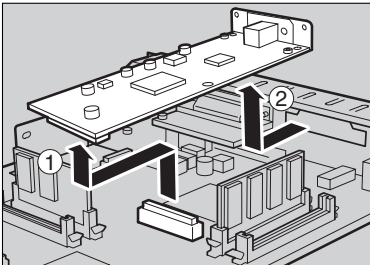

ZHBP450E

- 6** Attach the Bluetooth Interface Unit. Insert the end of the Bluetooth Interface Unit to the opening (①), and then push down until it clicks (②).

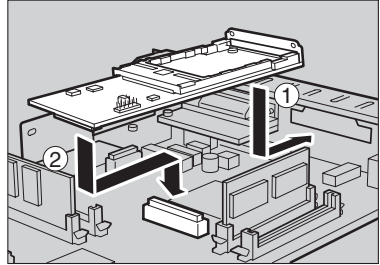

ZHBP190E

Confirm that the Bluetooth Interface Unit is firmly connected to the controller board.

- 7** Fasten the Bluetooth Interface Unit on the controller board using the screws removed in step **5**.

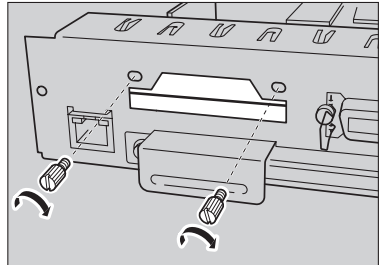

ZHBP200E

- 8** Insert the card slowly into the Bluetooth Interface Unit with its side labeled "INSERT" facing up until it stops.

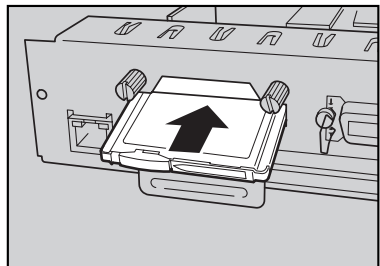

ZHBP530E

1

- 9** Press the antenna to extend it.

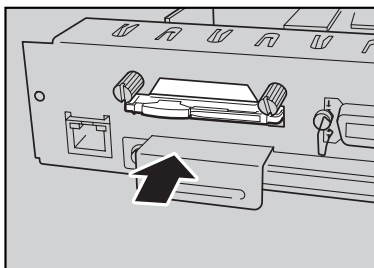

ZHBPAS30E

- 10** Attach the antenna cap over the antenna.

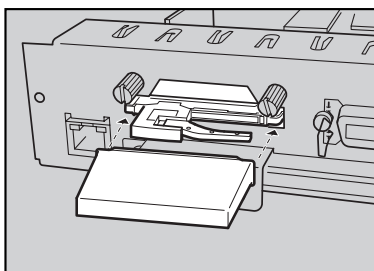

ZHBPAS20E

- 11** Adjust the Bluetooth module to the slot, and then insert vertically.

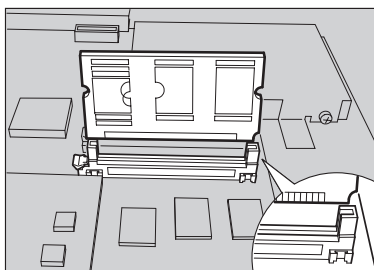

ZHBP540E

- 12** Align the controller board to the top and bottom rails, and then push in slowly until it stops.

Note

- When installing other options on the controller board, do not close the controller board, but go to the steps for installing the option.

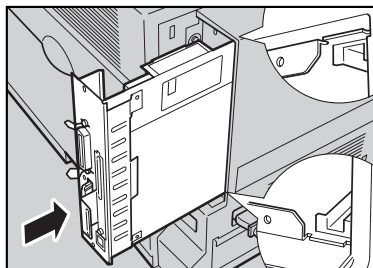

ZHBP550E

Important

- The printer may not work properly if the controller board is not set properly.

- 13** Fasten the controller board to the printer with the two screws removed in step 8.

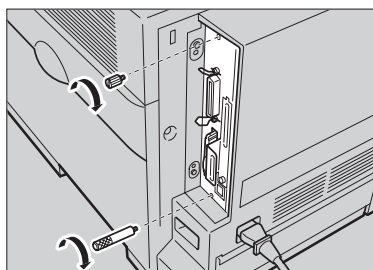

ZHBP560E

Network Interface Board Type 3000

⚠ CAUTION:

- Do not touch the inside of the controller board compartment. It may cause a machine malfunction or a burn.

⚡ Important

- ❑ Before touching the Network Interface Board, touch something metal to discharge any static electricity. Static electricity can damage the Network Interface Board.
- ❑ Do not subject the Network Interface Board Interface Unit to physical shocks.

1 Check the contents of the package for the following:

- ◆ Network Interface Board Type 3000

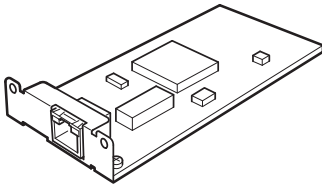

ZHBP910E

- ◆ Ferrite Core × 2

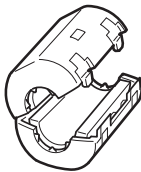

ZHBP911E

2 Turn off the power, and then unplug the power cable.

3 Remove the two screws that fasten the controller board on the back of the printer.

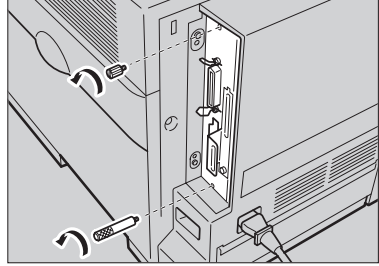

ZHBP9080E

The removed screws will be used in step 9 to fasten the controller board.

4 While holding the handle, pull out the controller board slowly.

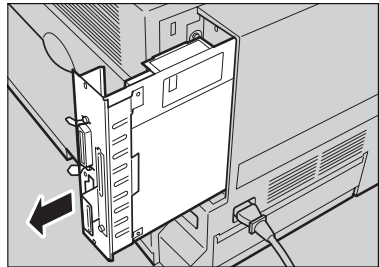

ZHBP9020E

5 Remove USB2.0 Interface Unit.

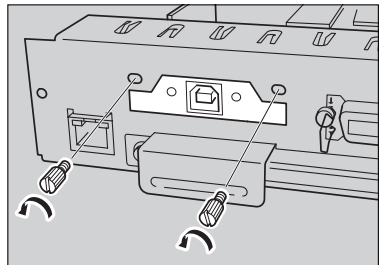

ZHBP8460E

Note

- The removed screws will be used in step 7.
- Lift the end of USB2.0 Interface Unit (1), and then remove it from the controller board (2).

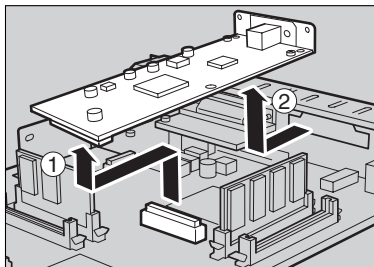

- 6** Attach the Network Interface Board. Insert the end of the Network Interface Board to the opening (1), and then push down until it clicks (2).

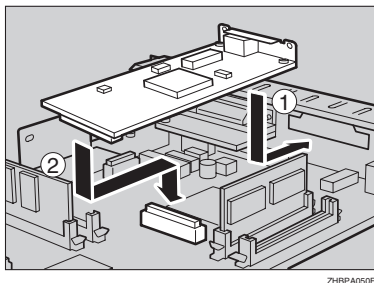

Confirm that the Network Interface Board is firmly connected to the controller board.

- 9** Fasten the controller board to the printer with the two screws that

- 7** Fasten the Network Interface Board on the controller board using the screws that you removed in step 5.

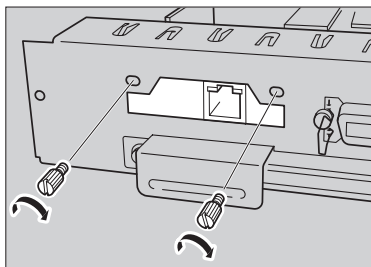

- 8** Align the controller board to the top and bottom rails, and then push in slowly until it stops.

Note

- When installing other options on the controller board, do not close the controller board, but go to the steps for installing the option.

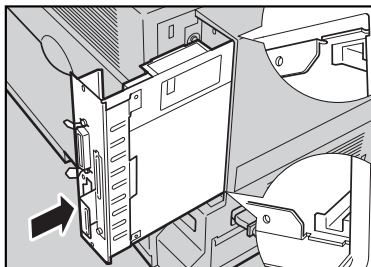

Important

- The printer may not work properly if the controller board is not set properly.

you removed in step 3.

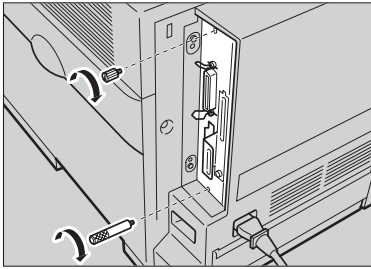

ZHBP A010E

Note

- ❑ After finishing installation, you can check whether the Network Interface Board is installed properly. Print the configuration page from the "List/Test Print" menu. If it is installed properly, you will see "Option Ethernet Board" for "Controller Option".
- ❑ If the Network Interface Board is not installed properly, reinstall it from step 2. If you cannot install it properly even after attempting reinstallation, contact your sales or service representative.

Reference

See "Making Printer Settings with the Control Panel" in the Administrator Reference for printing the configuration page.

Connecting the Network Interface Cable to the Network

- 1 Turn off the power
- 2 Loop the network interface cable and attach the ferrite core.

Note

- ❑ Attach two ferrite cores to the network interface cable. One of them must be attached close to the end of the cable (on the end closest to the printer). The other must be attached approximately 45 cm (18") (①) apart from the end. Attach each ferrite core with a loop.

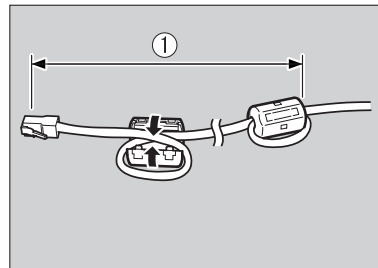

ZHBP P13E

- 3 Attach the network interface cable to the jack on the Network Interface Unit.

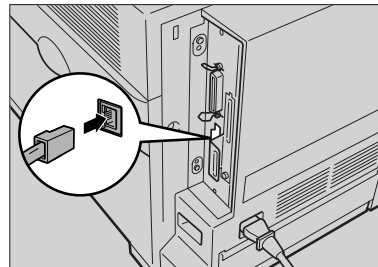

ZHBP 1470E

- 4 Connect the other end of the network interface cable to the network.
- 5 Turn on the power.

User Account Enhance Unit Type B

1

⚠ WARNING:

- **Do not place the IC2 lithium battery near or into fire, or it will explode and cause a burn.**
- **The User Account Enhance Unit installed on the controller board has a IC2 lithium battery which can explode if replaced incorrectly. Replace the User Account Enhance Unit only with the indicated one.**

⚠ CAUTION:

- **Do not touch the inside of the controller board compartment. It may cause a machine malfunction or a burn.**

🔧 Note

- Disposal should take place at an authorized dealer or an appropriate collection site. An IC2 lithium battery is inside the User Account Enhance Unit.
- If you dispose the unit, separate the IC2 lithium battery from the board, and then dispose of them according to the local regulations.

⚡ Important

- Before touching the User Account Enhance Unit, touch something metal to discharge any static electricity. Static electricity can damage the User Account Enhance Unit.
- Do not subject the User Account Enhance Unit to physical shocks.

- 1 Check the contents of the package for the following:

- ◆ User Account Enhance Unit

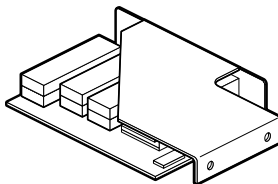

- ◆ Screw



- 🔧 Note

- The other screw supplied is not to be used.

- 2 Turn off the power, and then unplug the power cable.

- 3 Remove the two screws that fasten the controller board on the back of the printer.

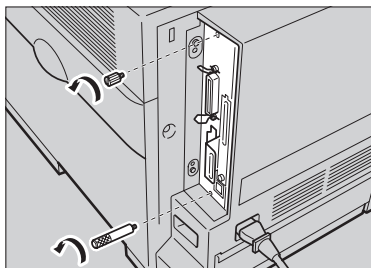

ZHBP080E

The removed screws will be used in step 8 to fasten the controller board.

- 4** While holding the handle, pull out the controller board slowly.

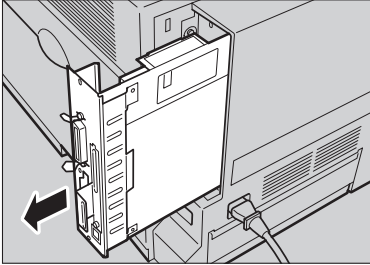

ZHBP020E

The User Account Enhance Unit is to be installed to the position shown in the illustration.

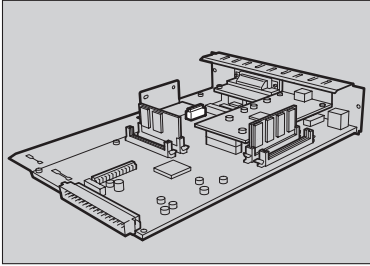

ZHBP130E

- 5** Set the User Account Enhance Unit on the controller board in the direction shown in the illustration.

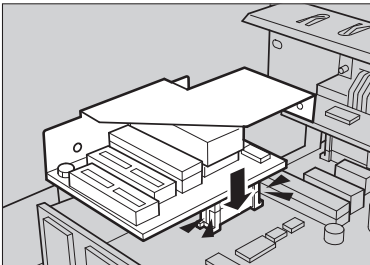

ZHBP140E

Confirm that the User Account Enhance Unit is firmly connected to the controller board.

- 6** Align the screw hole of the User Account Enhance Unit and the controller board, and then fasten the User Account Enhance Unit on the controller board using a supplied screw.

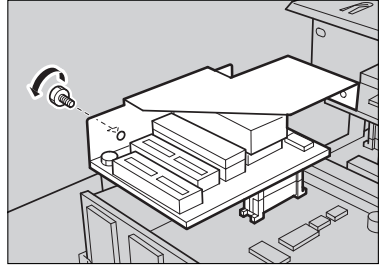

ZHBP150E

- 7** Align the controller board to the top and bottom rails, and then push in slowly until it stops.

 **Note**

- When installing other options on the controller board, do not close the controller board, but go to the steps for installing the option.

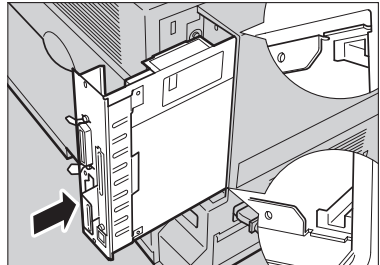

ZHBP070E

 **Important**

- The printer may not work properly if the controller board is not set properly.

- 8** Fasten the controller board to the printer with the two screws that you removed in step **3**.

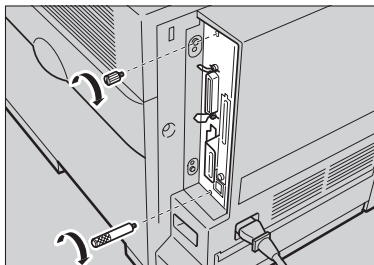

ZHBP010E

Note

- After finishing installation, you can check whether the User Account Enhance Unit is installed properly. Print the configuration page from the "List/Test Print" menu. If it is installed properly, you will see "Accounting Module" for "Controller Option".
- If the User Account Enhance Unit is not installed properly, reinstall it from step **2**. If you cannot install it properly even after attempting reinstallation, contact your sales or service representative.

Reference

See "Making Printer Settings with the Control Panel" in the Administrator Reference for printing the configuration page.

INDEX

1394 Interface Unit Type 4510, 6, 7, 19
802.11b Interface Unit Type A, 25

A

AD440 (Duplex Unit), 5, 11
Available Options, 3

M

Memory Unit Type C (SDRAM Module),
6, 7, 13

N

Network Interface Board Type 3000, 6
Network Interface Board Type 3000, 35

O

Options, 3

P

PAPER FEED UNIT Type 3000, 5, 8
Printer Hard Disk Type 3000, 6, 7, 16

U

User Account Enhance Unit Type B, 6, 7, 38

MEMO



RICOH COMPANY, LTD.

15-5, Minami Aoyama 1-chome,
Minato-ku, Tokyo 107-8544, Japan
Phone: +81-(0)3-3479-3111



Overseas Affiliates

U.S.A.

RICOH CORPORATION
5 Dedrick Place
West Caldwell, New Jersey 07006
Phone: +1-973-882-2000

The Netherlands

RICOH EUROPE B.V.
Groenelaan 3, 1186 AA, Amstelveen
Phone: +31-(0)20-5474111

United Kingdom

RICOH UK LTD.
Ricoh House,
1 Plane Tree Crescent, Feltham,
Middlesex, TW13 7HG
Phone: +44-(0)20-8261-4000

Germany

RICOH DEUTSCHLAND GmbH
Mergenthalerallee 38-40,
65760 Eschborn
Phone: +49-(0)6196-9060

France

RICOH FRANCE S.A.
383, Avenue du Général de Gaulle
BP 307-92143 Clamart Cedex
Phone: +33-(0)-821-01-74-26

Spain

RICOH ESPAÑA S.A.
Avda. Litoral Mar, 12-14,
08005 Barcelona
Phone: +34-(0)93-295-7600

Italy

RICOH ITALIA SpA
Via della Metallurgia 12,
37139 Verona
Phone: +39-045-8181500

Hong Kong

RICOH HONG KONG LTD.
21/F., Tai Yau Building,
181, Johnston Road,
Wan Chai, Hong Kong
Phone: +852-2862-2888

Singapore

RICOH ASIA PACIFIC PTE.LTD.
260 Orchard Road,
#15-01/02 The Heeren,
Singapore 238855
Phone: +65-830-5888

Model number: Aficio CL3000, CL3000DN

Printed in The Netherlands

EE (GB) G081-6530